

---

---

# DRIVETRAIN

---

---

## 1 Introduction

Vehicle sales in Japan in 2022 (including mini-vehicles) dropped 5.4% compared to the previous year, to 4.2 million vehicles. Continuing on from 2021, this was mainly due to a global shortage of semiconductors and disruptions to the parts supply chain caused by the COVID-19 pandemic. In addition, uncertainties affecting the automotive industry intensified as a result of rapid increases in interest rates due to concerns about inflation, exchange rate fluctuations, as well as high energy and raw material prices.

The rising global trend toward carbon neutrality is driving progress into the introduction of renewable energy and electrification centered on battery electric vehicles (BEVs). Sales of BEVs are growing rapidly partially due to preferential government policies toward electrified vehicles in countries and regions around the world. Similarly, sales of some BEVs in Japan are also strong, despite issues related to the availability of charging infrastructure. At the same time, automakers around the world have made a continuous stream of announcements detailing plans for new models and investments in BEVs, bringing the shift to electrified vehicles into sharper focus.

This article summarizes the latest drivetrains released in the automotive industry in 2022, and also takes a look at the technological trends paving the way for next-generation drivetrains.

## 2 Drive Systems for Hybrid Vehicles

### 2.1. Mazda CX-60 PHEV

The e-Skyactiv PHEV system is a parallel plug-in hybrid system capable of driving a vehicle by a combination of engine and motor power, or by motor power alone. It incorporates a 17.8 kWh lithium-ion battery (Fig. 1) capable of powering the vehicle on urban and suburban roads. This system runs in hybrid mode in the mid-

dle to high vehicle speed range where the fuel efficiency of the engine is good, helping to realize fuel-efficient and quiet performance while enabling excellent acceleration and a long range before refueling.

While driving in EV mode, the engine kicks in when high power is required or the charge of the lithium-ion battery falls below a certain level. The engine can be started by either a conventional starter system or by a clutch mechanism in the motor.

When the engine is started using clutch C1 (Fig. 2), the system prevents the transmission of torque fluctuations to the vehicle during the engine start process by slipping clutch C2.

The motor features concentrated winding ideal for the available narrow installation space and an integrated design with the 8-speed automatic transmission. These measures enable the optimum layout for the oil and cooling channels, as well as the bolt fixing points, resulting in

System output	241 kW
Engine power	138 kW
Motor output	129 kW
Battery capacity	17.8 kWh
EV range	75 km

Fig. 1 System Specifications

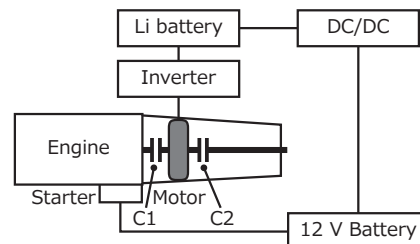

Fig. 2 System Diagram

compact exterior dimensions. When driven on engine power alone, the response time to accelerator operation is only 150 ms. With the motor engaged, this time is shortened even further to 90 ms.

Three driving modes are available: normal, EV, and sport. In EV mode, the system will drive the vehicle on battery power alone in everyday driving scenarios on urban and suburban roads, providing the driver does not require full acceleration. Then, in sport mode, the system increases the motor torque and heightens the acceleration and deceleration response.

### 2. 2. BYD Han DM-i

The DM-i is a series/parallel plug-in hybrid system with a focus on motor drive that is also capable of driving a vehicle by a combination of engine and motor power, or by motor power alone. On urban roads, the system realizes silent and smooth performance. When the battery charge is depleted, the system switches to hybrid mode to enable motor drive while charging the battery. During high-speed cruising, the system directly engages a reduction gear to enable highly efficient engine drive. Another notable feature is smooth dynamic performance without the need for a transmission. Under high load conditions, both the engine and motor are used to en-

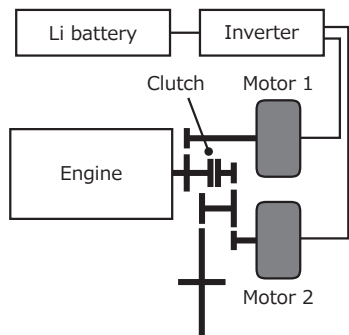

Fig. 3 System Diagram

Mode	System operation
EV	Clutch disengaged and vehicle driven by motor 2.
Series	Clutch disengaged, engine starts, and vehicle driven by motor 2 while power generated by motor 1.
Parallel	Clutch engaged and vehicle driven by engine and motor 2.
Engine directly connected	Clutch engaged and vehicle driven by engine alone.

Fig. 4 Operation of each Motor

hance acceleration performance through parallel hybrid operation.

This type of hybrid system switches between four different modes depending on the conditions. Figure 3 shows the system configuration and Fig. 4 explains the operation of each element in each mode. The clutch is disengaged in EV and series modes, enabling the vehicle to be driven using motor 2 alone. When the lithium battery charge is depleted, the engine is started and power is generated using motor 1. In parallel and engine directly connected modes, the vehicle is driven using engine power. When larger driving force is required, engine power is supplemented by power from motor 2.

As a result, in the Worldwide Harmonized Light Vehicles Test Cycle (WLTC), the system operates in EV mode 54% of the time, in series hybrid mode 28% of the time, and in parallel hybrid mode 18% of the time, realizing a fuel consumption of 5.1 L/100 km in the WLTC.

The motor uses rectangular wires and realizes a compact design by shortening the ends of the motor. The motor also has a slot filling rate of at least 70% and a volumetric power density of 44.3 kW/L. A direct oil cooling method is adopted from the inside of the rotor shaft to the coil. The motor speed is 16,000 rpm and maximum efficiency is 97.5%. The system has a highly efficient and simple structure with two motors laid out in parallel and a speed reduction gear consisting of one clutch and four gears. The clutch is a wet type clutch that helps to increase service life and enable smooth transitions between modes.

### 2. 3. Honda e:HEV

The e:HEV is a series/parallel hybrid system that can also be mounted on plug-in hybrid vehicles (PHEVs). This system provides three driving modes: EV drive mode in which the vehicle is driven by motor power alone, engine drive mode in which the vehicle is powered directly by driving force from the engine, and series hybrid drive mode in which the vehicle is driven by the motor while power is generated by the engine (Fig. 5) In

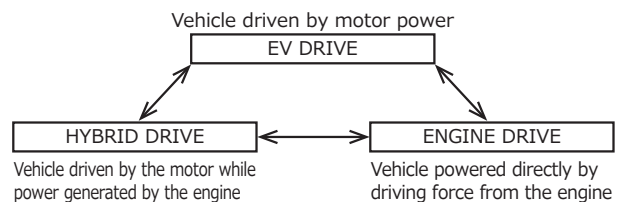

Fig. 5 Hybrid System Drive Modes

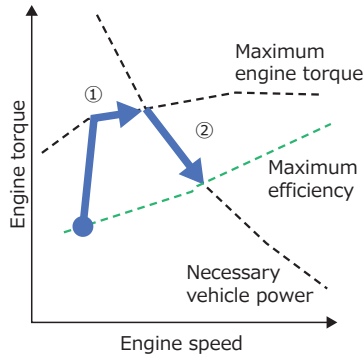

Fig. 6 Engine Speed Synchronized with Vehicle Speed

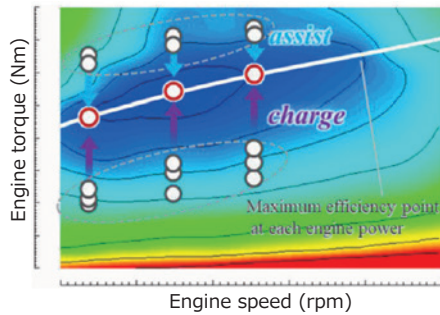

Fig. 7 Engine Thermal Efficiency

engine drive mode, the traction motor charges the battery and provides supplemental driving force to support high-efficiency engine operation. EV drive mode is used in less thermally efficient low engine speed regions and under low load conditions to boost fuel efficiency and help reduce noise on urban roads. Although the EV and hybrid modes cover most driving scenarios, engine drive is engaged during high-speed cruising when the engine operates most efficiently to help raise fuel efficiency.

The following main three improvements were incorporated into the new e:HEV system to boost fuel efficiency and driving performance.

(1) When the driver presses the accelerator in EV drive mode, the system prioritizes the supply of battery power to the power generation motor. This increases the engine speed after engine start and speeds up the power generation response. This approach shortens the time from accelerator operation to peak G by 1.5 seconds.

(2) When accelerating in hybrid drive mode, the system (a) uses surplus torque from the engine to ensure the necessary vehicle power for driving and (b) increases the engine speed while maintaining vehicle power as the vehicle speed rises (Fig. 6). If the engine speed becomes too high, the engine speed is temporarily lowered before being increased again. This additional control simulates

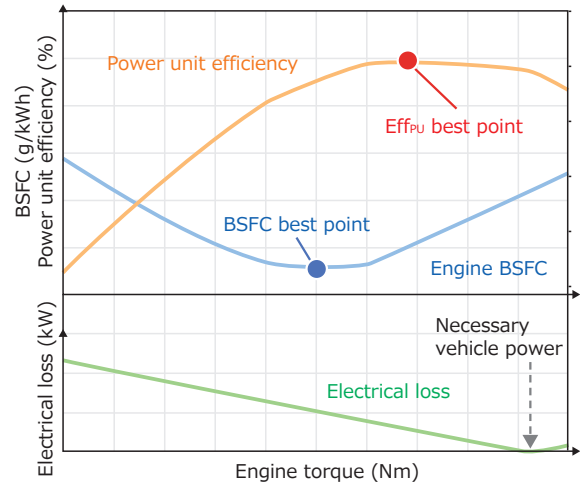

Fig. 8 Engine Thermal Efficiency and Electrical Efficiency

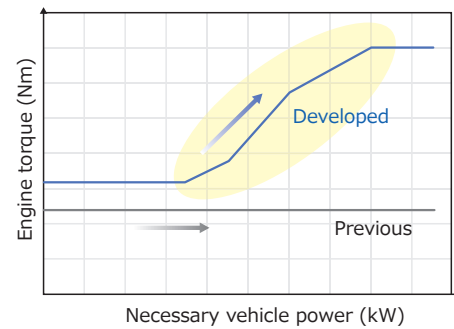
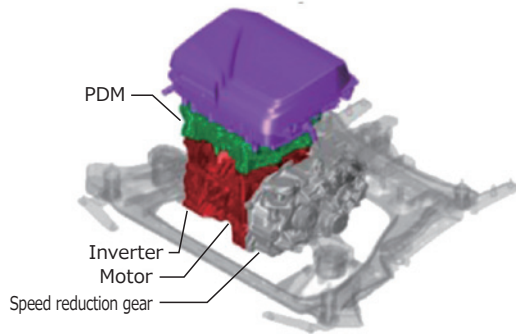

Fig. 9 Necessary Vehicle Power and Engine Torque in Engine Drive Mode

the experience of shifting. The rate of engine speed increase is fixed in accordance with the rate that the vehicle speed increases. As a result, the engine speed matches the driving feel created by acceleration.

(3) In engine drive mode, surplus torque is used to charge the battery when driving in low-load conditions (compared to the maximum thermal efficiency of the engine). In contrast, when driving in high-load conditions, the motor provides assistance to offset any shortfall in torque. This control helps to maintain the battery energy balance while also improving fuel efficiency (Fig. 7). However, since higher electrical losses during battery charging and discharging may adversely affect fuel efficiency, the overall efficiency of the system is optimized by varying the engine torque (Fig. 9) while monitoring both the thermal efficiency of the engine and electrical efficiency (Fig. 8). As a result, these controls improve fuel efficiency by 2.4%.



**Fig. 10** Powertrain Configuration

### 3 Electric Vehicle Powertrains

#### Nissan Sakura

The Nissan Sakura is equipped with a compact eAxle that can be mounted on mini-vehicles. Maximum motor power is rated as 47 kW under the voluntary standards of the Japan Automobile Manufacturers Association (JAMA). Maximum torque is 195 Nm, substantially higher than conventional vehicles equipped with a gasoline turbocharged engine, which usually achieve around 100 Nm. In everyday driving scenarios, this provides overwhelmingly powerful acceleration performance.

To mount the system in the limited space available in the engine compartment of a mini-vehicle, the component parts (motor, inverter, and speed reduction gear) were arranged in series to ensure space above the eAxle. This space is used to mount the charger, DC/DC converter, and junction box as an integrated power delivery module (PDM) (Fig. 10).

Integrating the motor and inverter reduce the number of cases and covers, and adopting a directly connected bus bar reduces the number of wiring harnesses and terminal blocks. In addition, adopting a plastic molding for the bus bar shortens the insulating distance. As a result, the overall system is 30% smaller in terms of volume and 15% lighter than a non-integrated system. In addition, the cooling channels were shortened to reduce the pressure loss of the channels and shorter power lines were adopted to lower electrical loss, helping to further reduce the loss of the overall system. All the high-voltage components can be stored within a metal case, which also helps to improve electromagnetic compatibility (EMC) performance by reducing the electric field intensity (Fig. 11).

The motor adopts rectangular wires, which have a

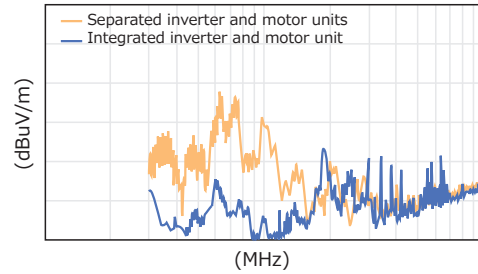

**Fig. 11** Electric Field Intensity in each Frequency Band

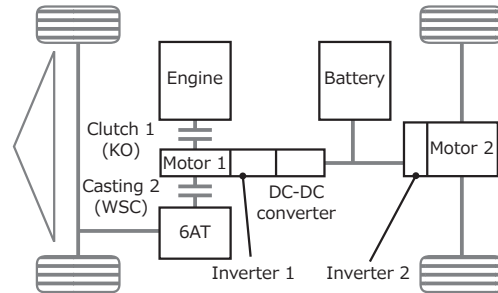

**Fig. 12** Hybrid System Diagram

roughly 9% higher space factor than round wires and improve efficiency by 2.5%.

### 4 Four-Wheel Drive Systems

#### Toyota Crown

The Dual Boost Hybrid System is a four-wheel drive (4WD) hybrid system consisting of a single-motor hybrid system at the front and a single-motor eAxle at the rear. By applying the driving force of these front and rear systems, the available grip at the front and rear wheels can be utilized to the maximum extent to control vehicle posture both on slippery low-traction roads and for dynamic performance during high lateral G acceleration via precise 4WD control.

The hybrid system at front includes the engine and motor 1 (Fig. 12). The eAxle at the rear consists of a speed reduction gear, motor 2, and inverter 2. During EV mode, 4WD is realized using motor 1 and motor 2 via battery power (Fig. 13). Under high-load conditions, such as when merging or overtaking on a highway, a part of the engine torque is used to generate power via motor 1 at the front. That power is added to the power from the battery to drive motor 2 at the rear (Fig. 14). Under high engine torque conditions, the deflection of the engine mounts increases and noise performance worsens. In this case, power is generated at the front and used to drive the rear wheels. This power is available from low engine

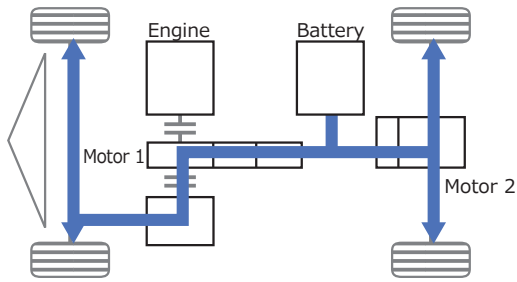

**Fig. 13** Energy Flow in EV Mode

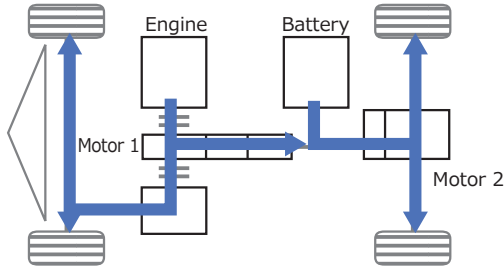

**Fig. 14** Energy Flow under High-Load Conditions

speeds to high torque regions, approximately doubling the available engine torque compared to a front-wheel drive vehicle with the same noise and vibration (NV) performance.

The rear eAxle uses a liquid-cooled high-power motor. Dynamic performance is enhanced on high-traction roads by expanding the usable range of the driving force distributed to the rear. The allocation of driving force to the front and rear wheels is guided mainly by feedforward control in accordance with state conditions such as the degree of accelerator operation, steering wheel angle, and the like to realize a natural feeling without response lag. The longitudinal driving force distribution ratio is set in accordance with the longitudinal vertical weight distribution ratio of the inner wheels when cornering, which have smaller tire friction circles. During high lateral G acceleration, the driving force distribution is increased to the rear to enable maximum use of the tire friction circles at both the front and rear wheels (Fig. 15), increasing the critical cornering performance by up to 25% compared to a conventional system. In addition, increasing the rear wheel drive torque during acceleration minimizes vehicle sinking in the rearward direction and helps realize a more direct sensation of acceleration.

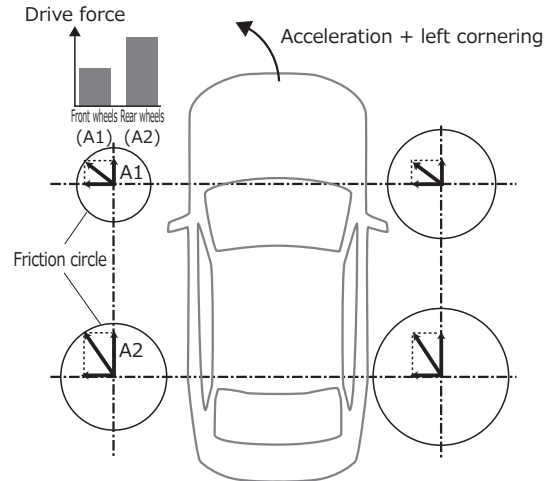

**Fig. 15** Maximum Utilization of Tire Friction Circles

## 5 Drivetrain Research Trends

As electrification advances to help achieve carbon neutrality by 2050, electrified components must be made even more efficient, smaller, and lighter in the same way as the components of conventional powertrains. At the same time, it is also important to reduce CO<sub>2</sub> emissions during production. In particular, since BEVs require large amounts of expensive batteries, low-cost components are required more than ever before. For this purpose, further advances in component and motor technologies to realize functional integration will be necessary. Since the resources required by electrified vehicles are concentrated in certain regions, the development of alternative materials and methods will be required alongside technologies to facilitate the recycling and reuse of materials. At the same time, as automated driving and digital technologies advance, energy and heat management will become more important than ever alongside power transmission functions. This will necessitate the development of cooperative and coordinated system and control technologies for the entire vehicle to enhance vehicle behavior and attitude.

Furthermore, reflecting the importance of electrifying a wide range of vehicles from compact mobility to heavy-duty trucks, the development of diverse and versatile technologies is likely to become even more important.