

# Vibration, Noise and Ride Quality

## 1 Introduction

Global warming is advancing and environmental problems are growing increasingly serious on a worldwide scale. Consequently, improving environmental technologies has become a top priority, even in the automotive industry. Customers already place a much higher level of importance on fuel efficiency and, in Japan, the popularization of fuel efficient vehicles, such as hybrid electric vehicles (HEVs), is continuing to advance. A great variety of research is also being carried out to improve the efficiency of new vehicle development and to achieve higher fuel efficiency while also ensuring excellent vibration and noise performance.

In the field of road traffic noise, concrete noise regulations that are in line with actual driving conditions are being put into effect. In 2014, Japan adopted UN-ECE R41-04, a regulation determined by the United Nations Economic Commission for Europe (UNECE), as a measure to help reduce the noise made by motorcycles when accelerating. In Europe, EU Regulation No. 540/2014 was adopted for the purpose of reducing the noise of all vehicles, including passenger vehicles.

In recent years, various new powertrain systems have been adopted that have different noise sources to conventional powertrains. Reports have described improvements to address these noise sources, such as the surge noise in turbocharged vehicles and the vibrations that occur when an HEV engine restarts. In terms of the vehicle system as a whole, research is continuing to make progress in reducing vehicle weight to help improve fuel efficiency, while other research is examining new analysis technologies to help shorten the vehicle evaluation period.

Among the many reported technologies to help reduce vehicle noise and vibration, research is continuing into creating a comfortable sound environment inside the ve-

hicle. One report even described research into comfortable sound conditions that compared engine sounds to musical instruments.

## 2 Road Traffic Noise

The noise generated by traffic has been regulated according to acceleration noise, and an upper limit value for that noise is determined in each country. In Japan, noise regulations have gradually become more stringent and multiple, comprehensive measures have been implemented to reduce traffic noise. As a result of these efforts, the rate of meeting environmental noise standards have steadily improved by at least 12% over the past 10 years (Fig. 1) (1)(2). However, traffic noise remains

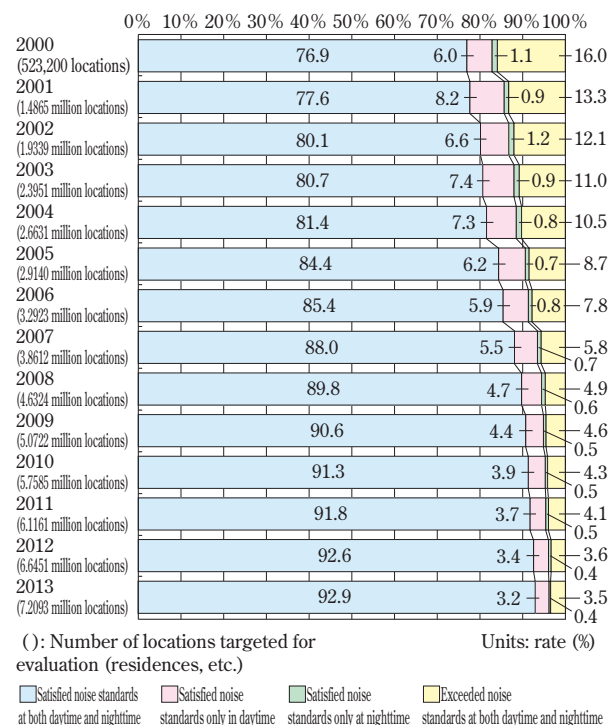

Source: Status of Motor Vehicle Traffic Noise during FY 2013, Ministry of the Environment homepage (<http://www.env.go.jp/press/upload/upfile/100217/26630.pdf>)

Fig. 1 Noise standard compliance in Japan (historical trend)

an issue in Japan. One reason for this may be that vehicle noise tests evaluate noise when the accelerator is fully depressed (i.e., when the throttle is fully open) even though this almost never occurs when passenger cars and motorcycles are driven in the real-world. Therefore, vehicle states during noise testing and in actual urban areas do not match (3). If vehicles continue to be designed and built to comply with these noise test standards, then a significant reduction in the traffic noise cannot be expected, even if the standard values for the acceleration noise are made more stringent. This means that a new test method is required that can evaluate the noise produced by vehicles in actual urban driving (4). Consequently, an international effort to examine possible revisions to acceleration noise test methods has begun.

These efforts have already born fruit. A new test method for evaluating motorcycle noise using conditions that are more in line with actual urban driving was incorporated into the international regulation, UN-ECE R41-04, which was adopted by the UNECE World Forum for Harmonization of Vehicle Regulations (WP 29). It went into effect starting in January 2014 (5).

The international standard that stipulates the acceleration noise regulations for passenger vehicles and that contains the new test method for evaluating vehicle noise using conditions more in line with actual urban driving is UN-ECE R51-03. Japan is now considering the introduction of this standard. In Europe, the European Commission (EC) adopted EU Regulation No. 540/2014, which is equivalent to R51-03, for acceleration noise in May 2014. The noise limit values in this regulation are scheduled to become stricter over the course of three stages to reduce noise from all vehicles, including passenger cars, light commercial vehicles, buses, and large buses. The first-stage noise level regulation is scheduled to start in July 2016 and the final full implementation of all stages of the regulation will likely take ten to twelve years (6).

Since overall vehicle noise has dropped due to a significant reduction in the noise generated by power unit systems, the contribution of tire noise has become relatively high. Therefore, WP 29 adopted a revised version of the regulation concerning tire noise (R117-02) that further reduced the regulation value by approximately 4 dB from the level in UN-ECE R117-01, which was stipulated in 2010. This new regulation value has been applied sequentially in Europe beginning in 2012 (7).

In April 2012, the Central Environmental Council of Japan published its second report on the future of vehicle-based noise reduction measures (3), which announced the decision to adopt UN-ECE R41-04 to help reduce motorcycle acceleration noise starting in 2014. In the case of passenger vehicles, the possibility of harmonizing Japanese regulations with UN-ECE R51-03 is also being considered. In addition, since tire rolling noise makes a large contribution to overall vehicle noise during steady-state driving, Japan is considering abolishing its own steady-state driving noise regulations from the standpoint of regulatory streamlining so that the international regulation concerning the rolling sound emissions of tires (UN-ECE R117-02) can be adopted (8).

The reviews of testing methods and the gradual strengthening of noise regulatory values described above are expected to lower the environmental noise generated by vehicles and improve the degree of achievement of environmental standards.

## **3 Noise and Vibration of Vehicle Components**

---

### **3.1. Power unit systems**

Every automaker is promoting the development of new technologies, such as smaller-sized engines, HEVs, or EVs, to meet the ever-increasing demands for better environmental performance.

However, in addition to environmental friendliness, customers are also demanding more comfortable vehicle interiors. This has prompted a large number of reports describing research into addressing the noise and vibration problems caused by these newly developed vehicle power units. There have also been many reports looking at how to reduce the calculation time and improve the prediction accuracy of CAE to raise the efficiency of vehicle development.

Recently, the most common method to achieve both good environmental and power performance from smaller engines has been to combine a turbocharger with a conventional small displacement engine. This has led to the publication of many research reports about abnormal noise generated from these power units. Turbocharged engines are affected by surge noise generated by the compressor. One report described a countermeasure for the side generating the vibratory force that suppresses surging by optimizing the opening and closing timing of the release valve. This same report also described the

addition of a resonator as a countermeasure on the transmission side (9). Another report examined the adoption of multiple resonators inside the air duct channel of a supercharged engine as a countermeasure against high-frequency pulsating sound (10).

In an HEV, the motor operates frequently to provide drive force and vibrations are produced when the engine restarts and when the engine is running. Some reports have described the use of CAE to optimize the motor and engine control parameters to help solve these vibration issues (11)(12). In an EV, the motor generates different types of noise to that in a conventional internal combustion engine. Countermeasures to this noise issue are being actively pursued using CAE analysis. Another report looked at building a new analysis method that could reproduce motor vibrations with good accuracy. This analysis method combined predictions of electromagnetic excitation force via electromagnetic field analysis with predictions of vibration via structural analysis. This report cited examples of lower vibratory forces being produced when the ring mode that was excited by the electromagnetic excitation force was raised to a higher order (13).

Recent years have also seen much research using CAE to help design exhaust system components. For example, countermeasures have been developed for air-flow sounds generated within the exhaust silencer using CFD to identify the location of the noise source and review the internal structure (Figs. 2 to 4) (14). It was also reported that a new method had been developed that replaces some portions of the model with one-dimensional models and impedance for the purpose of shortening the CAE calculation time, while still ensuring the same level of accuracy as a conventional full finite element model (FEM) (15)(16).

### 3.2. Drive and engine mounting systems

A new low-noise hybrid system for front-wheel drive vehicles has been developed that can be installed in the same space as a conventional transmission by placing a dry multi-plate clutch inside the motor and connecting the motor to the transmission via a floating mount. When the motor is built into the transmission, vibrations generated by the motor are transferred to the transmission case. Therefore, unpleasant motor noise that is then emitted from the case must be reduced. This research suppressed the vibrations using a floating mount with an elastic member at the anchorage point where the mo-

tor is fixed to the transmission case. Furthermore, the stiffness distribution is designed so that the anchorage point of the elastic member is placed at the node position of the ring vibration of the electromagnetic excitation force generated by the motor. The stiffness value of the elastic member is then optimized so that the eigenvalue (resonance frequency) of the motor vibration mode is outside the practical use region when the vehicle is being driven. In this way, the transfer of motor vibrations to the transmission case is reduced significantly and the noise radiated from the case is also reduced (17).

Although idling stop and hybrid systems help improve the fuel efficiency of vehicles, these systems generate vibrations when the engine restarts. These vibrations occur regardless of the driver's intent and are very noticeable. Therefore, reducing these vibrations is necessary to improve product appeal. One report described the development of a control method that identifies the timing of the vibrations when the engine restarts and then drives the active control engine mounts (ACM) at an amplitude that cancels out these restart vibrations. Engine start-up is a transient phenomenon that happens over a short period of time, which makes it difficult to adopt controls that detect vibrations using sensors and then provide feedback to the engine. However, there is a correlation between the timing of the power plant vibrations generated when the engine starts and the crank angle of the engine. This correlation can be utilized to predict the size and timing of the vibrations and

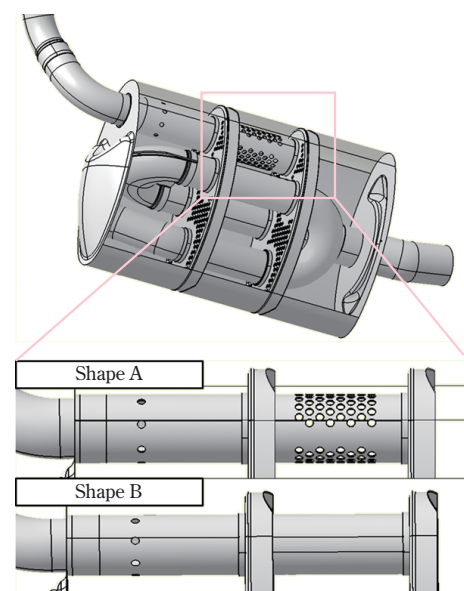

Fig. 2 Shape difference specifications

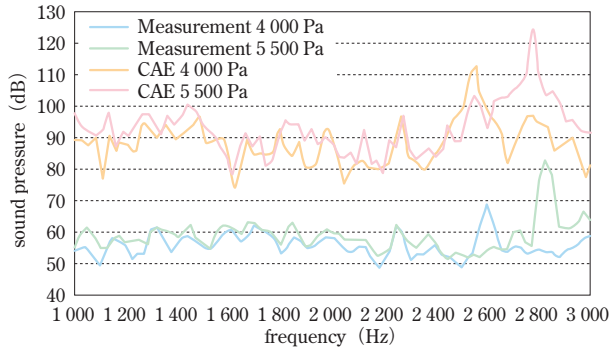

Fig. 3 Comparison results of pressure conditions

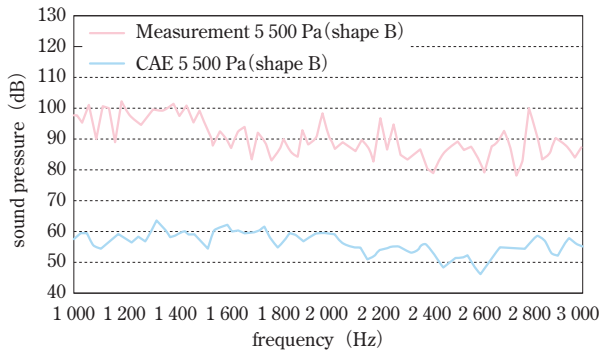

Fig. 4 Results with different shapes

then cancel them out. The ACMs generate the required amplitude via suction using a current applied to the coil inside the actuators and an opening operation using the spring force of the oscillating plate rubber. A DC current is applied in advance and the oscillating plate is forced to move toward the suction side, so the amplitude drive that is required to cancel out the vibrations becomes possible from the first time that the current is controlled. The two control methods described above reduce the transmission of vibrations to the vehicle body (18).

### 3. 3. Tires and suspension systems

The increasing use of motors and other powered devices has reduced the amount of noise generated from power units and systems. This has added to the importance of improving road noise from road surface inputs. Automakers are also looking to shorten vehicle development times to reduce development costs and the number of prototype models that are needed. As a result, the realization of an actual road noise simulation method and ways to enhance the efficiency of development work have become important issues.

In the case of tires, vibration inputs are generated by the contact between the tire and the road surface and it

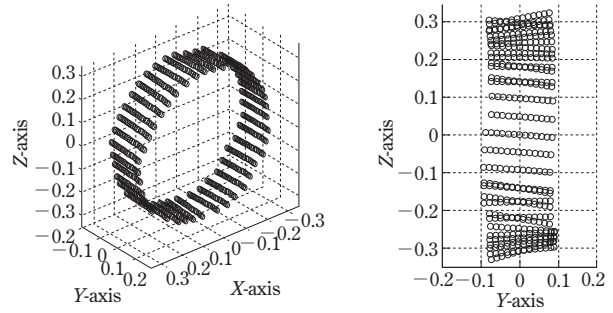

Fig. 5 Mode shape of lateral bending mode

is important to accurately identify the degree to which these inputs are transmitted to the wheels and suspension. In the region of 200 Hz or less that contributes greatly to road noise performance, the main inputs to road noise during actual driving are the axle transmission force and the axle transmission moment. It was reported that simply calculating the response of the hub axis to the fluctuations in these two forces when a mass produced tire and wheel are mounted on the hub enables identification as a CAE model (19).

Most recent research has focused mainly on the radial direction of the tire. However, there is a growing focus on the horizontal translation and lateral bending modes of tires since these excite vibrations in the lateral direction of the vehicle. One report described a dynamic model established from a cylindrical shell and the use of a non-stretching deformation subjunctive to help analyze the vibration behavior. The natural vibration frequency of the tire's lateral bending mode and the Rayleigh method were used to confirm that the vibrations of the tire in the lateral direction could be derived from the non-stretching deformation subjunctive. This analysis was then used to clarify the contributions made by the tire lateral bending primary mode and the stiffness of the tire sidewall (Fig. 5) (20).

In some cases the changes made to reduce the acoustic sensitivity of the vehicle body can cause the transmission force of the suspension to increase, preventing improvements or actually worsening road noise performance. Therefore, the mechanism was analyzed with a focus on changes in the transmission force of the suspension. It possible to calculate the transmission force of the suspension via a theoretical equation using the transfer function synthesis method, which is one of the substructure synthesis methods. As a result, it was found that the changes in the transmission force of the suspension

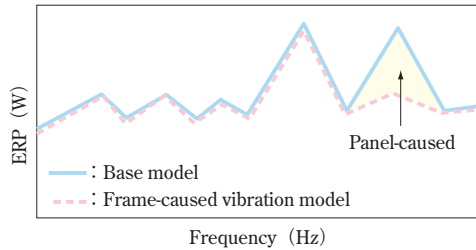

Fig. 6 Concept of this technique

are caused by changes in the comprehensive compliance of the suspension mounting points. It was reported that the use of this theoretical equation reduced the amount of rework during development (21).

### 3. 4. Body and interior materials

In addition to the growing demands for quiet vehicles, automakers must also consider the demands for lower cost and weight to help improve fuel efficiency when designing vehicle bodies and selecting interior materials. Manufacturers are looking for development methods that can carry out evaluations in a short period of time, efficiently achieve both of those requirements, and help ensure good vibration and noise performance.

It was reported that a new system for analyzing sound blocking and insulating materials was being examined in addition to the SEA and HSEA methods. This system divides up the surfaces in the vehicle interior and associates them with the acoustic characteristics of the parts using the same concept as in the SEA method. This makes it possible to examine the specifications during the design stage (22).

Acoustic radiation is energy emitted by the vibration of the vehicle body panels. It is determined by the acoustic radiation efficiency and the vibration amplitude of the panel surface. Since the acoustic radiation efficiency is difficult to control, it is ignored by the equivalent radiated power (ERP) concept. A new technique for analyzing the weak points of vehicle body acoustic characteristics that focuses on ERP was developed. In this technique, the amount of ERP that is caused only by the body panels is identified by subtracting the ERP found in a frame-caused vibration model from the amount of ERP in a normal base model. This technique is used to determine whether vibrations are caused by the vehicle frame or body panels (Fig. 6) (23). The frame-caused vibration model was created by combining a panel model that has stiffness only and zero mass with a frame model with added panel mass (Fig. 7) (23).

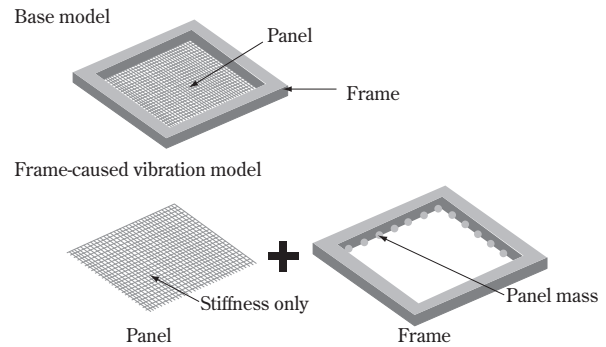

Fig. 7 Base model and frame-caused vibration model

Other research includes the creation of models incorporating interior materials in addition to vehicle body panels to improve the accuracy of the estimated vehicle acoustic characteristics. Interior material characteristics are a critical part of interior material modeling and the setting of Young's modulus in particular requires extra attention. Research has been carried out into a method for identifying the most suitable value of Young's modulus for creating models, using results measured based on ISO standards. In this research, interior materials were classified into different categories and the appropriate Young's modulus for the model was identified by assigning a coefficient to each of the categories. It was reported that modeling the interior materials using Young's modulus improved the estimation accuracy of the vehicle body acoustic characteristics. It is likely that research into similar techniques that analyze vehicle acoustic characteristics while taking into account the coupling of the vehicle body and interior materials will continue to make progress in the future (24).

## 4 Sound and Sound Quality

Research into comfortable sounds continues and various innovative measures, such as biological information, are being used to determine how people feel certain sounds as pleasant.

To identify the conditions that cause people to interpret an engine sound during acceleration as comfortable, an objective evaluation of certain biological quantities, such as electrocardiogram (ECG) measurements and cerebral blood flow measurements, was reported in addition to a subjective evaluation based on the SD method, while comparing engine sounds to musical instruments. The results of this research showed that, for example, if "very comfortable" was set as the target variable

and the adjectives “noisy,” “sharp,” “rough,” and “good tonality” were analyzed as the explanatory variables in a psychoacoustic evaluation, then low roughness and good tonality made large contributions to a feeling of comfort. Research that identified the inverse of the degree of brain activity as indicative of the degree of comfort reported that the presence of higher-order harmonic components in the sounds of both engine acceleration and musical instruments helped to increase the degree of comfort that was felt (25).

In contrast, it was reported previously that factors other than hearing must also be taken into consideration for people to feel that the sound of an engine or EV motor is comfortable. A newly developed driving simulator found that the comfortable sound level differed depending on the location of the person in the vehicle and the information received. The driver receives both visual and driving operation information. The front passenger only receives visual information and rear passengers receive neither visual nor driving information. These people feel sound volumes differently. It was also reported that feelings of comfort differ depending on the state of vehicle operation, for example, full acceleration, slow acceleration, driving at a steady speed, decelerating, and the like. Another report using the same analysis methods also indicated that the seating position within the vehicle changed how people felt about the volume or frequency of the EV motor sound, when only these variables were changed (26). Research into vehicle sounds that factors in the different perceptions of all vehicle passengers will likely continue in the future.

## 5 Ride Comfort

---

New technologies that enhance ride comfort are being developed continuously. However, rather than a simple means of transportation, vehicles are now regarded as a high value-added living space and ride comfort has become a very important performance requirement.

In recent years, one major trend of ride comfort research is the level of comfort of the vehicle’s seats. Many papers and reports have examined what exactly people feel and describe as comfort and what sort of benchmarks should be used to help express it. The seat types and the gender of the test subjects have been used as parameters. Seats have been evaluated based both on subjective levels of comfort as well as objective evaluations obtained from body pressure dispersion and

seat contact areas. The results of these evaluations were aggregated using an analysis of variance, resulting in the identification of a certain correlation (27). Research also examined the gap between actual seats and the subjective expectations of users. This research used techniques from the field of economics to express customers’ preferences as a utility function and then the concept of comfort was modelled using functions such as “comfortable feeling,” “degree of luxury,” “lightness,” and “users’ expectations” (28).

Other research is continuing to examine ways of quantitatively evaluating seats by simulation, such as using dummies (human body models) to simulate a human body sitting on a model seat. These human body models have been created using magnetic resonance imaging (MRI) and biological data, and can reproduce the interactions between the seat and the skin, fat, and muscle, as well as between the muscle and bone. Thanks to these complex models, manufacturers are now able to consider the factors that reduce comfort, the interfacial stress between muscle and bone, and to incorporate new ways to improve comfort and reduce stress in seat designs (29). Approaches such as these, from a variety of different viewpoints, are being undertaken and utilized in seat design to enhance ride comfort.

Actively controlled suspensions are effective means of achieving high levels of both handling and ride comfort, which is usually very difficult. Many reports have described the use of road surface preview information, which vehicles have started collecting in recent years, in the development of new suspension control systems.

This road surface preview technology is largely known as a collision avoidance technology that helps to improve vehicle safety. However, a new challenge for this technology is to see how thoroughly road surface information can be incorporated into suspension control to help improve ride comfort.

It was reported that the use of cameras with active light sources is an effective method of measuring road surface profiles (30). This is a low-cost and space-saving method that uses existing collision avoidance system cameras and requires no additional equipment. It was also reported that this method has an equivalent level of accuracy to laser-based road surface measuring systems.

The next step is to determine how best to utilize this road surface information. It was reported that a suspension control, which predicts the road surface ahead

of the vehicle and factors in the time difference for the front and rear wheels to pass over that road surface, as well as the difference in road surface at the left and right wheels, is an extremely effective way of improving ride comfort (31)(32). It was also reported that devising control logic strategies using optimization techniques achieved robust control that could handle actual road surfaces (33).

In all of the examples cited above, the new technologies being developed show great potential for improving ride quality without adversely affecting other areas of vehicle performance. Therefore these technologies are likely to continue improve and mature in the future.

#### References

- (1) Status of Motor Vehicle Traffic Noise during FY 2014, Ministry of the Environment (MOE, Japanese only):  
<http://www.env.go.jp/press/upload/up-file/100217/26630.pdf>
- (2) Guidelines of Countermeasures for Preventing Traffic Noise Issues along Roads and Railroads (Japanese only), MOE:  
[http://www.env.go.jp/doc/toukei/data/2014\\_6.44.xls](http://www.env.go.jp/doc/toukei/data/2014_6.44.xls)
- (3) Future of Vehicle-based Noise Reduction Measures (Japanese only), MOE:  
<http://www.env.go.jp/press/files/jp/19306.pdf>
- (4) International Harmonization of Standards Related to Vehicle Noise (Japanese only), National Traffic Safety and Environment Laboratory:  
[https://www.ntsel.go.jp/forum/2012files/1106\\_1545.pdf](https://www.ntsel.go.jp/forum/2012files/1106_1545.pdf)
- (5) Acceleration Noise Standards for Motorcycles (Japanese only), MOE:  
[https://www.env.go.jp/council/former2013/08noise/y081-10/mat03\\_2.pdf](https://www.env.go.jp/council/former2013/08noise/y081-10/mat03_2.pdf)
- (6) Trends of European Standards and Certification Systems (Japanese only), Geneva Office of Japan External Trade Organization (JETRO):  
[https://www.jetro.go.jp/world/europe/standard/pdf/2014may\\_june.pdf](https://www.jetro.go.jp/world/europe/standard/pdf/2014may_june.pdf)
- (7) Interim Report of Tire Noise Standard Committee (March 2014) (Japanese only), Ministry of Land, Infrastructure, Transport and Tourism (MLIT):  
[http://www.mlit.go.jp/jidosha/jidosha\\_tk10\\_000031.html](http://www.mlit.go.jp/jidosha/jidosha_tk10_000031.html)
- (8) Progress reports of UN four-wheel vehicle acceleration noise regulation (R51-03), etc. (Japanese only), MOE:  
<https://www.env.go.jp/council/07air-noise/y071-15a.html>  
[https://www.env.go.jp/council/07air-noise/y071-15/mat%2004.pdf/07\\_%E8%B3%87%E6%96%9915-4.pdf](https://www.env.go.jp/council/07air-noise/y071-15/mat%2004.pdf/07_%E8%B3%87%E6%96%9915-4.pdf)
- (9) Kuang et al., Surge Noise Identification and Control of Automotive Turbochargers, SAE Paper No. 2014-01-2053 (2014)
- (10) Murakami et al., Development of New QR25DER Engine with Supercharger for New FF-Hybrid System, Nissan Technical Review, No. 74, pp. 32-35 (2014)
- (11) Jo et al., Development to Improve Engine Starting Vibration in Hybrid Vehicle with Low Number of Cylinders, Toyota Technical Review, Vol. 60, pp. 67-71 (2014)
- (12) Tsuruta, Control Parameter Optimization for Reduction of 2nd Order Vibration in Hybrid Drive Mode of SPORT HYBRID i-MMD, Honda R&D Technical Review, Vol. 26 No. 2, pp. 137-143 (2014)
- (13) Miyakawa et al., Vibration Mechanism of the Motor for EV by Analysis and an Example of the Vibration Reduction Countermeasures, Transactions of Society of Automotive Engineers of Japan, Vol. 45 No. 1, pp. 109-113, 20144156 (2014)
- (14) Kanai et al., Predictive Simulation of Flow-induced Noise using CFD, Honda R&D Technical Review, Vol. 26 No. 2, pp. 149-156 (2014)
- (15) Medeiros et al., Predicting Transmission Loss of Mufflers with Perforated Tube Elements using the Boundary Element Method, SAE Paper No. 2014-01-2055 (2014)
- (16) Steen Andersen et al., Transfer Matrix Coupling Approach for Predicting the Acoustic Performance of a Complete Aftertreatment Exhaust System, SAE Paper No. 2014-01-2056 (2014)
- (17) Akasaka et al., Technology of Floating Mounting Structure of Motor be housed Dry Multiplate Clutch in for New Hybrid Vehicle, Transactions of Society of Automotive Engineers of Japan, Vol. 45 No. 2, pp. 279-284, 20144278 (2014)
- (18) Yone, Development of Active Control Engine Mount System for Reduction of Resonance Vibration

- tion at Engine Restart, Honda R&D Technical Review, Vol. 26 No. 2
- (19) Uesaka et al., Method of Experimental Identification of Change in Dynamic Characteristics of Rolling Tires, Proceedings of the Society of Automotive Engineers of Japan, No. 23-14, pp. 15-20, 20145107 (2014)
- (20) Matsubara et al., Vibration Analysis of Tire Lateral bending Mode by Rayleigh's Method, Proceedings of the Society of Automotive Engineers of Japan, No. 63-14, pp. 21-24, 20145294 (2014)
- (21) Ichikawa, Analysis of Mechanism of Change in Body Input Forces Related to Low-frequency Road Noise, Proceedings of the Society of Automotive Engineers of Japan, No. 23-14, pp. 9-14, 20145103 (2014)
- (22) Tada, Establishment of Evaluation Method of System Performance for Vehicle with Soundproof Packages, Proceedings of the Society of Automotive Engineers of Japan, No. 102-14, pp. 13-16, 20145790 (2014)
- (23) Shinbo et al., Development of Factor Analysis Technology for the Equivalent Radiated Power of Panels and the Like (Japanese only), Proceedings of the Society of Automotive Engineers of Japan, No. 63-14, pp. 1-4, 20145333 (2014)
- (24) Kuroda et al., Examination of FEM Modeling Method of Resin Parts for NVH, Proceedings of the Society of Automotive Engineers of Japan, No. 23-14, p. 21-24, 20145291 (2014)
- (25) Arimitsu et al., Similarity Evaluation between Automobile Acceleration Sound and Musical Instrument Sound Based on Subjective and Objective Evaluation, Transactions of Society of Automotive Engineers of Japan, Vol. 45 No. 1, pp. 115-120, 20144157 (2014)
- (26) Yamaguchi et al., Impression Change of EV Driving Sound in Consideration of Audio-visual Information and Driving Intention, Transactions of Society of Automotive Engineers of Japan, Vol. 45 No. 5, pp. 859-864, 20144660 (2014)
- (27) Park et al., Analysis of Body Pressure Ratio for Evaluation of Automotive Seating Comfort, SAE Paper No. 2014-01-0456 (2014)
- (28) Pinkelman, A Consumer Utility Model of Automotive Seating Comfort: Discomfort, Comfort Character, and Expectations, SAE Paper No. 2014-01-0454 (2014)
- (29) Laurent et al., Human Modeling and CAE Based Subjective Seat Comfort Score Correlation, SAE Paper No. 2014-01-1980 (2014)
- (30) Nakamura et al., Preview Ride Comfort Control Based on Road Surface Estimation Using Cameras and Active Light, AVEC 14, 20149321 (2014)
- (31) Yamamoto et al., Preview Ride Comfort Control for Electric Active Suspension (eActive3), SAE Paper No. 2014-01-0057 (2014)
- (32) Kaldas et al., Influence of Active Suspension Preview Control on Vehicle Ride and Braking Performance, SAE Paper No. 2014-01-0862 (2014)
- (33) Kaldas et al., Preview Enhanced Rule-Optimized Fuzzy Logic Damper Controller, SAE Paper No. 2014-01-0868 (2014)